

MODEL 8710
DIGITAL COMMUNICATOR
PROGRAMMER
REFERENCE MANUAL

AT&T MODEL 8710 DIGITAL COMMUNICATOR PROGRAMMER

The AT&T Model 8710 Digital Communicator Programmer programs the Model 8700 Digital Communicator. You can program from either the customer's site, or remotely over the phone lines. In addition to programming the communicator, you can shunt or unshunt reporting channels, program the test reports and many other useful features. You can also remotely program using the AT&T Model 8711 Remote Programming Package which requires a modem and IBM PC compatible computer.

The Programmer displays menus for all operations. Operation is so simple that you will not likely need this manual after your first reading.

TOP VIEW

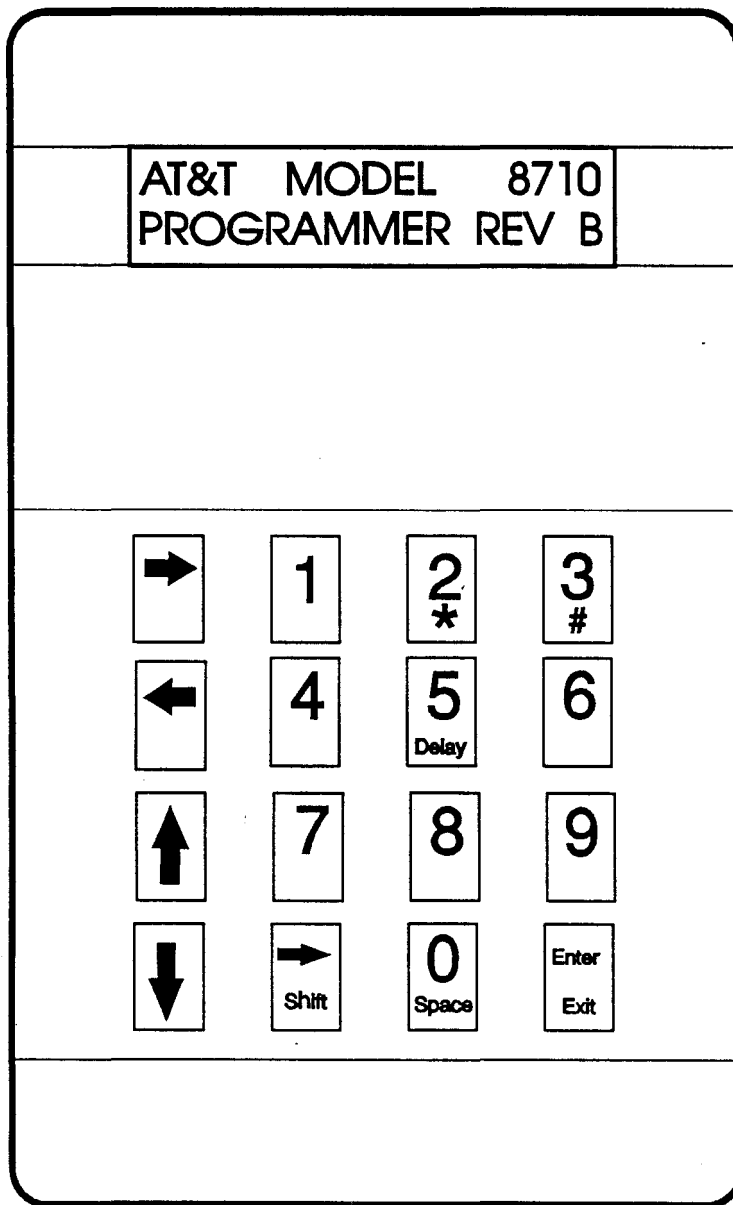

END VIEW

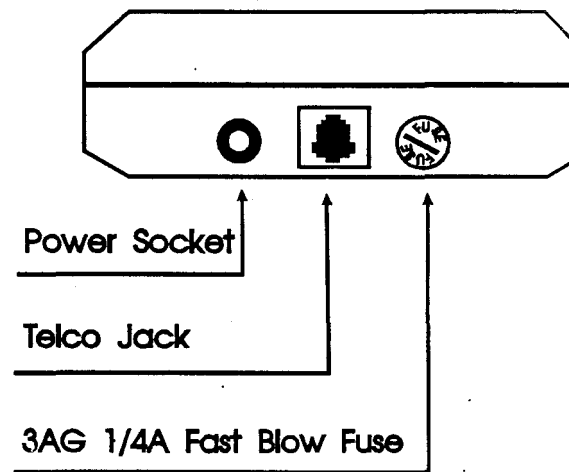

ABOUT THE KEYS



KEYS 0 - 9

You can program all options by typing in the value using the numerical keys 0 through 9. Because the model 8710 Programmer also displays all available values for each option, you can use the Up/Down cursor keys to scroll to the desired value.

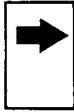

CURSOR KEYS

The Model 8700 Digital Communicator stores the information you wish to program in "addresses" called Command Locations. Command Locations can store from 1 to 6 programming functions, depending on the Command Locations use.

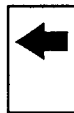

There are four cursor keys; Right, Left, Up, and Down. Use the Up and Down keys to select Programmer functions as well as "addresses" of Command Locations. Also use the Up and Down cursor keys to scroll through a range of desired values. Use the Left and Right cursor keys to select a specific Digit Position within a Command Location.



SHIFT KEY

The Shift key allows you to get two uses from some of the keys. When you press the Shift key, the upper left hand corner of the display will show (right arrow). If the next key you press is 2, 3, 5, 0, or Enter, the function written in red will be entered.

If you press the Shift key and then decide that you do not want to shift, press the Shift key again. It is a toggle action. You can also press any non-shift key which will automatically exit from the shift mode.



+

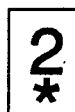

STAR KEY

The star key is used in the telephone number if required by the phone company when performing certain functions. Functions you might use include speed dialing and Cancel Call Waiting. You can program the * any where in the phone number that the phone company will allow.



+



POUND KEY

The # key is used in the phone number if required when performing certain phone company options.

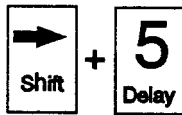

DELAY KEY

The Delay key is used to program a 2 second delay when the Model 8710 Digital Communicator Programmer dials a phone number. It will be displayed in the phone number as a comma (.). You can program as many delays as needed.

Note: To program delays in the phone numbers that the Digital Communicator dials, use a *5.

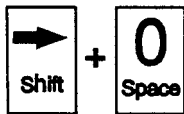

SPACE KEY

The Space key is only used when programming the phone number the programmer will call to connect to the communicator. If the previous phone number was longer than the new phone number, use the space key to erase the excess numbers.

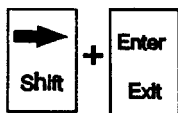

EXIT KEY

The Exit key is used to exit from the programming mode. When you have completed programming, press the Shift, then the Enter key. The Programmer will present you with the Main Menu.

You can use the Exit key to back up through the menus until you reach the top level menu. Also use the Exit key to stop the Digital Communicator connection attempt.

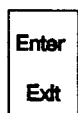

ENTER KEY

When you have completed programming a Command Location, you must press the Enter key. This transfers the information from the display to the programmer's RAM.

You do not have to re-enter all the information in a Command Location. If you only want to make one or two changes, use the cursor key to move to the desired Digit Position. When you press the Enter key, after making the desired changes, the cursor will move to the left, over to the Command Location. You can then use the Up or Down cursor keys to move to another Command Location.

Note: If the programmer is powered down, all data can be lost. To save the data, use the **SAVE TO MEMORY ?** (write to 8710 EEPROM) or **DOWNLOAD DIALER ?** (write to communicator EEPROM) programmer operations.

PROGRAMMER FUSE

The Programmer is protected by a 1/4 Amp, 3AG fuse. If the Programmer display does not light when power is supplied, check the fuse. Remove power from the communicator. Twist the fuse cap counter clockwise until the fuse cap pops out. Replace with the same size fuse, if necessary. Push the fuse cap in and turn clockwise to lock into place. When properly installed, the fuse cap will be flush with the case.

LOCAL PROGRAMMING CONNECTIONS

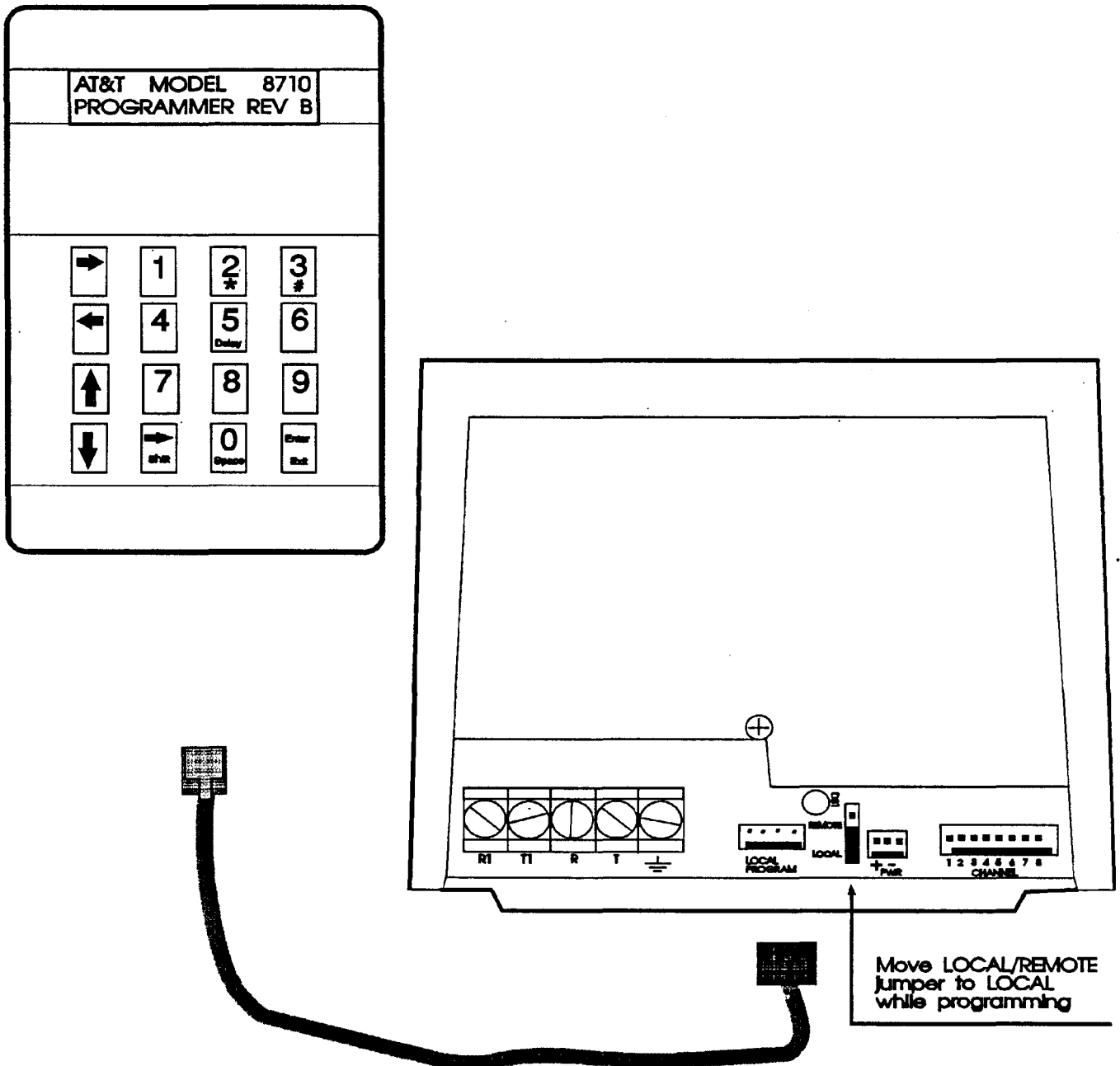

Using the Model 8710 Digital Communicator Programmer

CONNECTING LOCALLY

You can program the communicator either locally or remotely. To program locally, you will need the Direct Connect Programmer Cord.

1. The Digital Communicator must be powered up.
2. Disconnect the Digital Communicator from the phone line. The communicator must be disconnected to prevent programming interference.
3. Plug the Direct Connect Programmer Cord on to the 4 pin **LOCAL/PROGRAM** connector located on the Digital Communicator. The connector is polarized.
4. Plug the Direct Connect Programmer Cord's modular plug into the end of the Programmer.
5. The Programmer will power up and display its revision number. You are now ready to program the communicator.

AT&T MODEL 8710
PROGRAMMER REV B

6. Move the **LOCAL/REMOTE** jumper on the Digital Communicator to the **LOCAL** position.

7. Press the Up or Down cursor keys until the display reads **LOCAL CONNECT ?**. Press the Enter key.

8. The display will ask you to enter your Passcode. The Passcode is the 6 digit number that is assigned to each communicator. The passcode remains with the communicator and must be used whenever it's necessary to access the communicator with the programmer. If you wish to change the Passcode to one of your own choosing, type in your chosen six digit Passcode and press Enter.

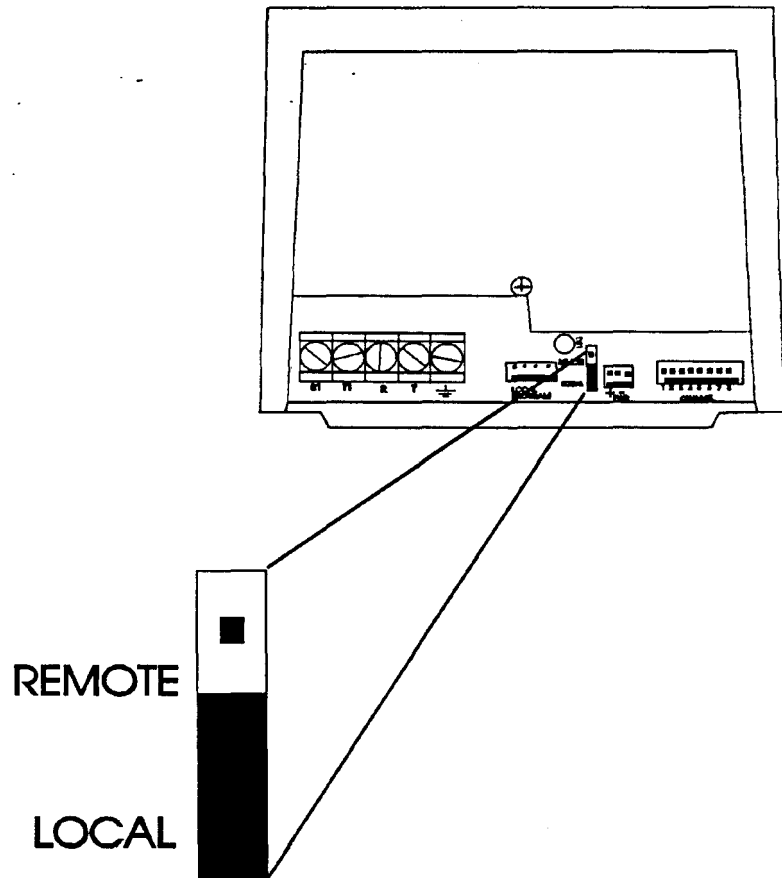

Using the Model 8710 Digital Communicator Programmer

Note: It is highly recommended that each communicator is programmed with a unique Passcode that is recorded on paper and kept in a safe place. When a customer's account is to be accessed with the programmer, an authorized person would have to look up the corresponding Passcode and make it available to the employee doing the work.

9. The Model 8710 Programmer will show you the connection progress. It will display, in turn, **WAIT FOR ANSWER**, **HANDSHAKE**, and **SENDING PASSCODE**. When it makes the interactive link, the display will show **EDIT DATABASE ?**. Once the connection process is complete and the Programmer and communicator are interactive, the display will continually flash a small **X** in the upper left hand corner of the display.

10. You are now ready to start programming, please go the section titled **HOW TO USE THE PROGRAMMER** on page 10.

Note: If you connect locally, you will not be able to shunt channels. Any channels that are shunted, and the watchdog are automatically reset when you move the Local/Remote jumper to the Local position.

DISCONNECTING LOCALLY

To disconnect, when you have completed programming, move the Local/Remote jumper on the Digital Communicator to the Remote position and disconnect the Programmer Cables from the Digital Communicator.

CONNECTING OFF-SITE

To program remotely, you will need the Power Converter and a 4 conductor Remote Programming cord phone cord with modular plugs on each end and a ground wire.

1. The Digital Communicator must be powered up.
2. Plug the Power Converter into the Programmer and 110VAC receptacle. The Programmer will power up and display its revision number.

AT&T MODEL 8710 PROGRAMMER REV B

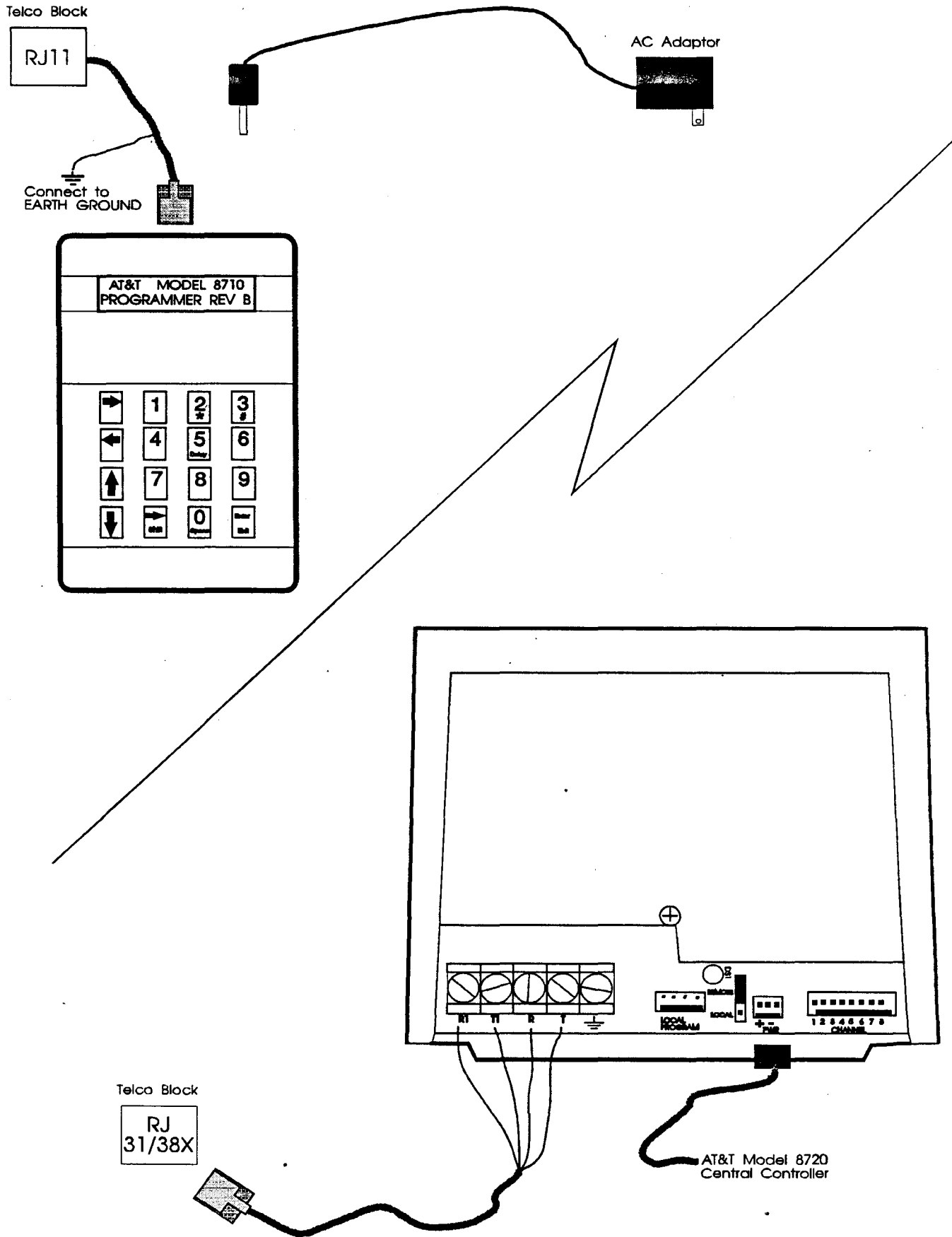

Using the Model 8710 Digital Communicator Programmer

3. Plug one of the Remote Programming Cord's modular plugs into the end of the Programmer. Plug the end with the ground wire into a telephone line which is terminated in a 4 pin modular jack (RJ11C). Connect the ground wire to earth ground. You are now ready to program the communicator.

Note: The Programmer will only work on loop start telephone systems. It will not work on ground start or pay phone lines.

Note: The ground wire protects the programmer and the technician who is using the programmer from harm if high voltage or current transients should enter the phone line during programming.

4. Press the Up or Down cursor keys until the display reads **DIAL REMOTE ?**. Press the Enter key.

5. The Programmer will display **ENTER PHN NMBR ?**. Press the Enter key. You can program up to 16 digits for the phone number. This is the phone number the Digital Communicator is wired to at the particular subscriber's premises. Type in the number the same way you would dial it. If you need to program a *, #, 2 second pause, or a space, use the Shift key followed by the appropriate key. When you have completed programming the phone number, press the Enter key.

6. Press the Down arrow key once, then the Enter key. The Programmer will dial either pulse or touch-tone (DTMF). The Programmer displays **DTMF OR PULSE ?** Use the Up or Down arrow to select the dialing type. Choose DTMF if you are dialing from touch-tone service. If you are not sure, select PULSE. Press the Enter key.

7. Press the Down arrow key once. The display will read **EDIT PASSCODE ?**. The Passcode is the 6 digit number that is assigned to each communicator. The passcode remains with the communicator and must be used whenever it's necessary to access the communicator with the programmer. If you wish to change the Passcode to one of your own choosing, press Enter. Then type in your chosen six digit Passcode and press Enter.

Note: It is highly recommended that each communicator is programmed with a unique Passcode that is recorded on paper and kept in a safe place. When a customer's account is to be accessed with the programmer, an authorized person would have to look up the corresponding Passcode and make it available to the employee doing the work.

8. The Programmer is now ready to connect to the Digital Communicator. Press the Down arrow key until **DIAL OUT ?** is displayed. Press the Enter key.

9. The display will show you the connection progress which will display, in turn, **DETECT DIAL-TONE, DIALING, WAIT FOR ANSWER, HANDSHAKE,** and **SENDING PASSCODE.** When the interactive link is established, a small **X** will flash in the upper left hand corner of the display, and the display will show **EDIT DATABASE ?.**

10. You are now ready to start programming, please go to the section titled **HOW TO USE THE PROGRAMMER** on page 10..

DISCONNECTING REMOTELY

You must properly disconnect from the communicator when programming is complete. Press the Exit key until you are back at the main menu selections. Use the Up or Down cursor keys to move to **DISCONNECT ?.** Press the Enter key. The programmer and communicator will hang up. Disconnect the Programmer power and phone cables.

UNPLANNED DISCONNECT

When you are remotely programming, the programmer may automatically disconnect from the communicator without you requesting it. This is caused by noise or interruptions on the telephone line. The programmer has error detection logic to prevent error caused mis-programming. Each Command Location is transmitted along with error checking information. When it detects an error, the programmer re-transmits the Command Location up to 5 times. If there are 5 consecutive errors, the programmer will disconnect from the communicator.

One source of noise is Call Waiting tones. Call Waiting is an optional telco service. It places a momentary tone on the phone line if a second call comes in while the subscriber is on the line with the first call. The tone causes errors if you are remote programming.

Some phone companies provide a Cancel Call Waiting feature. It allows you to shut off the Call Waiting tone while making a call. When you hang up from making the call, Call Waiting is restored. To activate Cancel Call Waiting, you must program in special numbers in front of the phone number you are calling. In most telephone exchanges that provide Cancel Call Waiting, the code is *70.

Example: The phone line that your programmer is connected to has Call Waiting and Cancel Call Waiting. You want to de-activate Call Waiting while programming. The phone number the AT&T Model 8700 Digital Communicator is connected to is 555-1212. When the programmer displayed **ENTER PHN NMBR ?,** you would key in *705551212[Enter]. Call Waiting tones would be disabled while you were programming the account, but would re-activate as soon as you disconnected from the account.

Note: You can only Cancel Call Waiting tones on the phone line you are calling from, not the phone number you want to call. If the phone line the communicator is wired to also has Call Waiting, you cannot stop those tones from interrupting the remote programming.

If the programmer disconnects before you are ready, simply re-call the account. From the main menu, use the Up or Down arrow keys until the display reads **DIAL REMOTE ?**. Following the procedure starting at step 4 on page 8.

HOW TO USE THE PROGRAMMER

When the Programmer is powered up, it presents you with several primary selection menus, each providing additional options to choose from. You can see each primary function by pressing the Up, or Down arrow keys. Once a primary function has been selected, by pressing the Enter key, all of its available options can also be scrolled through using the Up and Down arrow keys.

EDIT DATABASE ?

The Programmer always works with the program stored in the Programmer's Electrically Erasable Programmable Read Only Memory (EEPROM). Once stored, the information is known as the database. For now, use the Up and Down arrow keys to select **EDIT DATABASE ?** and press the Enter key. The Programmer will display the beginning of a long list of Digital Communicator programming options. These options provide the communicator with all the information it needs to properly report alarms to the central station. To see all the options at once, refer to the AT&T DIGITAL COMMUNICATOR PROGRAMMING SHEET. Beginning with the section on PROGRAMMING OPTIONS found on page 18, each will be discussed in detail.

Return to the primary menu by momentarily pressing Shift and then Exit.

LOCAL CONNECT ?

This menu option allows you to directly connect to the Digital Communicator without using phone lines for either the communicator or the Programmer.

DIAL REMOTE ?

Use this menu option to call up the Digital Communicator from any standard telephone line. To successfully connect, you will need to know the phone number and the passcode of the Model 8700 Digital Communicator at the subscriber's premises.

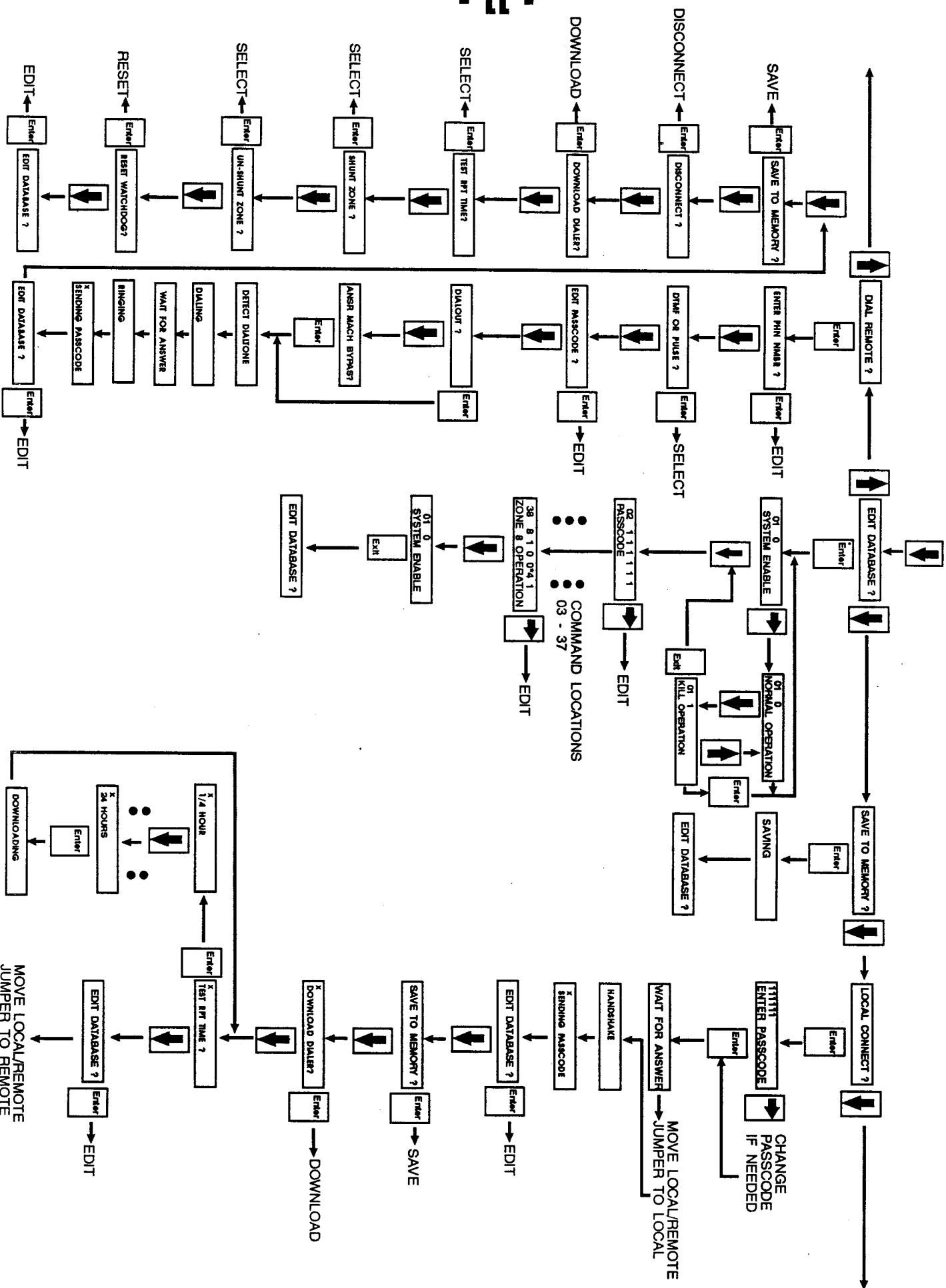

DISCONNECT ?

If you connected to the communicator by **DIAL REMOTE ?**, you have to disconnect by moving to this menu and pressing the Enter key. This menu will not display if you have connected to the Digital Communicator using the **LOCAL CONNECT ?** method.

If you have direct connected using **LOCAL CONNECT ?**, you must disconnect by moving the **LOCAL/REMOTE** jumper back to the **REMOTE** position.

Note: You must move the **LOCAL/REMOTE** jumper back to the **REMOTE** position. If the jumper remains in the **LOCAL** position, the Digital Communicator will remain disabled. It will not be able to report any alarms to the central station.

SAVE TO MEMORY ?

Once you have made changes to the program, you can save the program to the Programmer's database. Press the Enter key. The display will show **SAVING** while the program is written to EEPROM.

Note: If you do not save the program, any changes will be lost when the power is removed from the Programmer.

DOWNLOAD DIALER ?

After you have edited the data base, you will want to transfer the information to the Digital Communicator's memory. Select **DOWNLOAD DIALER ?** and press the Enter key. The display will flash **DOWNLOADING** while the information is being transferred.

TEST RPT TIME ?

There are two different times associated with the Test Report Timer. The time interval between test reports is programmed in Command Location 16 (Test Report Send Interval). When the communicator reports a test report, the next test report will be transmitted at the same time of day, at the next interval. The default value sets the time interval at 7 days.

If you have programmed test reports, you might want to set the time of day that the test reports transmit. The test timer will transmit its first test report 24 hours after you power up the communicator. You can change the time of the first report by selecting one of the following times for **TEST RPT TIME ?**:

1/4 hour	3 hours	10 hours	18 hours
1/2 hour	4 hours	12 hours	20 hours
1 hour	6 hours	14 hours	22 hours
2 hours	8 hours	16 hours	24 hours

If you enter a value and press the Enter key, the next test report will transmit that many hours later. All following test reports will transmit at the new time of day. This allows you to change the time of day that test report transmit.

Example: You powered up the communicator at 3:30PM. You want test reports to transmit to the central station around midnight. If you set the **TEST RPT TIME ?** for 8 hours, test reports will transmit at 11:30PM. You could have also set the value at 10. This would have caused test reports to transmit at 1:30AM.

Caution: If it is necessary to change the **TEST RPT TIME ?**, apply power to the communicator only when the installation is complete. If you apply and then remove power before the communicator can transmit its first test report, the communicator may lock up. Once the communicator has reported its first report, you can apply or remove power at any time.

SHUNT ZONE ?

If you are having excessive alarms from an account, you might want to temporarily shunt out the affected channel. This might be necessary due to long distance phone charges or central station overloading. Use the Up and Down cursor keys to select **SHUNT ZONE ?** option and press the Enter key. Use the Up and Down cursor keys to select the channel to shunt. Press the Enter key. If you want to shunt more than one channel repeat the process until you have shunted the desired channels. If you want to shunt all channels, press the Down cursor until the display shows **SHUNT ALL ZONES ?**, then press the Enter key

Note 1: This does not affect the operation of the Model 8720 Central Controller. The local sounders and displays will still operate normally.

Note 2: Shunted channels remain shunted until you remove them remotely using the Programmer, until you remove them using the model 8711 Remote Programming Package, or until you remove and replace the **LOCAL/REMOTE** jumper.

UNSHUNT ZONE ?

When you are ready to remove a shunt(s), cursor to this option and press Enter. Use the Up or Down keys to select the channel you want to un-shunt. Repeat the process or select **UN-SHUNT ALL ?** and press Enter.

RESET WATCHDOG ?

The AT&T Digital Communicator has a safety feature called a Watchdog. This circuit checks the microprocessor to insure that it is running. If the watchdog detects a failure, it will automatically reset the communicator to get it running again. The account program will not be changed. The red LED on the Digital Communicator will stop flashing and lock on steady when the watchdog detects a failure.

To reset the watchdog LED move the cursor to the **RESET WATCHDOG ?** and press the Enter key. The Watchdog LED will also be reset when you move the **LOCAL/REMOTE** jumper from **LOCAL** to **REMOTE**.

PROGRAMMING GUIDELINES

The Model 8700 Digital Communicator is programmed by entering data into 24 different Command Locations found in its database. Each Command Location is numbered with a 2 digit address. Depending on the Command Location, there can be from 1 to 6 Digit Positions. The Digit Positions hold the programming values. For convenience, we number the Digit Positions from left to right. When you are finished programming a Command Location, you must press the Programmer's Enter key.

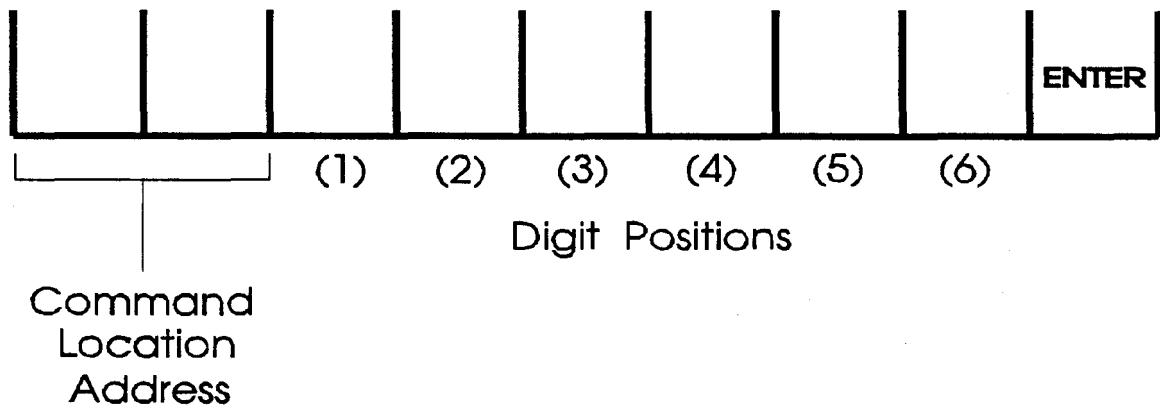

FILLING UNUSED POSITIONS

You might not use all programming options for all your installations. With the exception of the Account Numbers and the Phone numbers, all Command Locations must be programmed. If you are not using the function represented by a Location, you must still program that Command Location with a valid entry. In the case of account numbers and phone numbers, program 0's in the leading unused positions.

KEYPAD CONVERSIONS

The model 8710 Digital Communicator Programmer does not have all the keys of a computer keyboard. The Programmer automatically converts some programming entries to special key strokes.

This sounds more complicated than it really is. The Programmer shows you all the programming options. Scroll through them until you reach the desired value. Press the Enter key. For the curious, the following table shows the key stroke differences. You can see that you have to press the Shift key followed by a number key when programming the hexadecimal numbers A, B, C, D, E & F.

Keypad Entry	0	1	2	3	4	5	6	7	8	9	*0	*1	*2	*3	*4	*5
Computer Entry	0	1	2	3	4	5	6	7	8	9	A	B	C	D	E	F
Decimal Value	0	1	2	3	4	5	6	7	8	9	10	11	12	13	14	15

DEFAULT VALUES

The Digital Communicator is shipped with default values. These are shown in this manual and the programming sheet as (.). Once you have changed a programming value and pressed the Enter key, the new value will be written into the Programmer's RAM and will remain there as long as power is applied to the Programmer or until you change it. To save programmed values for subsequent use, exit the database by pressing the Shift key and then the Enter key. Use the Up and Down cursor keys to select the **SAVE TO MEMORY ?** option, and press the Enter key.

COMMAND LOCATIONS BY FUNCTION

Passcode	COMMAND # 02
Channels 1 - 8	COMMAND # 31 - 38
ALARM RECEIVER SELECT	
ALARM REPORTING CODE	
ALARM RESPONSE TIME	
RESTORAL RECEIVER SELECT	
RESTORAL REPORTING CODE	
SWINGER KILLER SHUNT	
Communications	
CALL ATTEMPTS	COMMAND # 05
DIAL TYPE	COMMAND # 05
PHONE RING TYPE	COMMAND # 05
REMOTE PROGRAM RING COUNT	COMMAND # 05
SYSTEM ENABLE/KILL	COMMAND # 01
RECEIVER 1 - ACCOUNT NUMBER	COMMAND # 06
RECEIVER 1 - MESSAGE FORMAT	COMMAND # 03
RECEIVER 1 - RECEIVER FORMAT	COMMAND # 03
RECEIVER 1 - PHONE NUMBER	COMMAND # 07 - 09
RECEIVER 2 - ACCOUNT NUMBER	COMMAND # 10
RECEIVER 2 - MESSAGE FORMAT	COMMAND # 04
RECEIVER 2 - RECEIVER FORMAT	COMMAND # 04
RECEIVER 2 - PHONE NUMBER	COMMAND # 11 - 13
Events	
SHUNT RECEIVER SELECT	COMMAND # 15
SHUNT REPORT CODE	COMMAND # 15
TEST REPORT SEND INTERVAL	COMMAND # 16
TEST REPORT RECEIVER SELECT	COMMAND # 16
TEST REPORT CODE	COMMAND # 16
STATUS RECEIVER SELECT	COMMAND # 14
STATUS REPORT CODE	COMMAND # 14

PROGRAMMING OPTIONS

The following information covers, in detail, all 24 Command Locations used for programming data into the Model 8700 Digital Communicator. To enter this area, use the Up or Down arrow keys and scroll to **EDIT DATABASE ?** and press Enter. Each Command Location will appear as a two-digit number on the left of the screen with its corresponding function appearing below it.

Alongside each Command Location are additional "fields" or "Digit Positions" which further help define the Command Location. By pressing the Right arrow key, the cursor will move, in turn, to each Digit Position, and its description will appear on the lower line of the display.

When you have made the selection of your choice, press Enter. The cursor is then returned to the Command Location. Your entry has been stored in the proper location and you are ready to proceed to the remaining areas.

Once you have programmed all 24 Command Locations, exit the database by pressing Shift and then Enter. you may then want to send the program to the communicator by choosing **DOWNLOAD DIALER?** from the primary menu selections and/or you may wish to save the programmed data in the database for easy retrieval. If so, choose **SAVE TO MEMORY ?** from the primary menu selections.

COMMAND # 01 SYSTEM ENABLE

This option allows you to disable all communicator functions except remote or local programming at one convenient Command Location. This is useful when converting an account from local to monitored, monitored to local, or when shutting off service to the communicator is required.

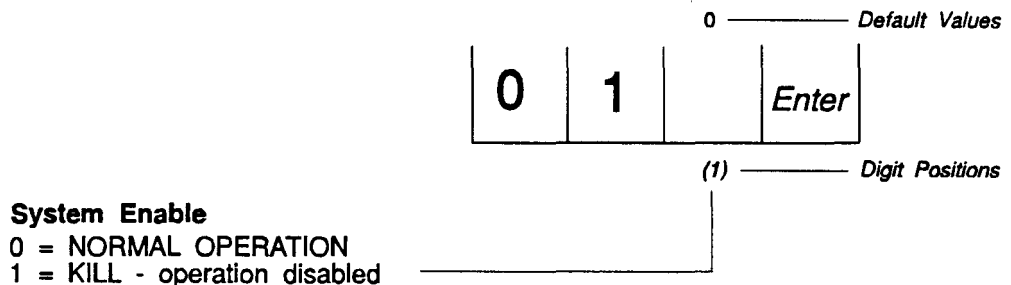

COMMAND # 02 Passcode

The Passcode must be entered before the communicator will allow programming. If you change the Passcode, be sure to record the new Passcode. Without it, you will not be able to program the communicator, either locally or remotely. All six digits must be entered.

		1	1	1	1	1	1	——— Default Values
0	2							Enter
	(1)	(2)	(3)	(4)	(5)	(6)	——— Digit Positions	

Passcode
Valid entries are 0 - 9

COMMAND # 03 RECEIVER 1 COMMUNICATION FORMAT

This location controls the reporting formats to Receiver #1. The first Digit Position in the Command Location determines the receivers handshake frequency and the speed of data transmission.

The second Digit Position determines the number of digits in the account number, the number of digits in the alarm code, and whether it will be single or two round reporting. Single round reporting is often required when reporting to older digital receivers. Single round reporting is less desirable since it does not expand the signal to tell you what specific event occurred.

This is a sample of the second Digit Position display: 3/1 SGL 0.5 SEC. The first digit determines the length of the account number. The digit after the slash (/) is the number of digits in the reporting code. The 0.5 SEC or 2.0 SEC is the number of seconds of delay after the handshake, before the communicator transmits the first data round.

Check with your central station to determine the correct format. Available formats are:

- 3/1 Single, .5 sec delay
- 3/1 Single, 2 sec delay
- 3/1 Extended, .5 sec delay
- 3/1 Extended, 2 sec delay
- 4/2
- 4/1
- 4/9 (ADEMCO DTMF)

The following table identifies valid transmission and message format combinations:

	3/1	3/1 Extended	4/2	4/1	4/9
Slow A	X	X	X	X	
Fast A	X	X	X	X	
Slow B	X	X	X	X	
Fast B	X	X	X	X	
Sumcheck 2300	X	X			
Sumcheck 1400	X	X			
ADEMCO DTMF					X

It is important to note that not all receivers will receive all valid transmission and message format combinations.

For all formats a maximum of eight messages may be transmitted per call. In the case of the 3/1 Extended format the extension counts as a message.

The alarm codes are interpreted differently by each receiver and are defined in each receiver's user manual. The following table defines extension meaning for different types of reports:

Report Type	Extension Meaning
Alarm	Zone Number
Restore	Zone Number
Shunt	Zone Number

3/1 Single

3/1 Single format consists of 3 digits of account number followed by 1 digit of alarm code. This format only conveys general information about the event.

Message Description

123 2 Zone 2 alarm for account 123 where alarm reporting digit for zone 2 is a 2.

123 E Restore report for account 123 where restoral report digit is an E.

3/1 Extended

3/1 Extended format consists of 3 digits of account number followed by 1 digit of alarm code. The extension is sent as a separate message in the same phone call. The extension message consists of the alarm code portion of the primary message repeated in place of the account number with the extension in place of the alarm code.

Message	Description
123 1	Zone 2 alarm for account 123 where alarm reporting digit for zone 2 is a 1.
111 2	
123 E	Zone 2 restore report for account 123 where restoral report digit is an E.
EEE 2	

The extensions for zone alarms are suppressed in the case of the Radionics Sumcheck formats. Zone alarms are characterized by alarm codes 1 through 8. The alarm codes for each zone must be set the same as the zone number.

Message	Description
123 2	Zone 2 alarm for account 123
123 E	Zone 2 restore report for account 123 where restoral report digit is an E.
EEE 2	

4/2

4/2 format consists of four digits of account number followed by 1 digit of alarm code followed by 1 digit of extension.

Message	Description
1234 12	Zone 2 alarm for account 1234 where alarm reporting digit for zone 2 is a 1.
1234 92	Zone 2 restore report for account 1234 where reporting digit is a 9.

4/1

4/1 format consists of four digits of account number followed by 1 digit of alarm code.

Message	Description
1234 1	Account 1234 where the reporting digit is 1.
1234 9	Account 1234 where the reporting digit is 9.

4/9 (DTMF)

4/9 format consists of 4 digits of account number followed by 9 digits of alarm information. Information about all eight zones plus the status channel are transmitted at the same time. Zone numbers are represented by digit positions while the 9th digit signifies the type of event in the first 8 digits. Any new event triggers a transmission at which time all nine channels will report.

Unlike other formats, the values that you program for the Reporting Codes (Alarm, Restoral, Status, or Shunt) are not transmitted. The values are pre-determined by the 4/9 format. As long as you program in any code other than Report Disable, the format will automatically send the following reports:

Code	Description
1	New Event (previously unreported)
3	New Restore (previously unreported)
5	Normal (no event since last restore)
6	Previously reported event still in effect.

The following table lists the codes and descriptions for the status channel:

Code	Description
3	Zone shunt report in previous eight channels.
6	System Status report (Watch Dog, Failed to Communicate, or completed remote programming)
7	Zone alarm report in previous eight channels.
9	Test Report.

4/9 (DTMF) Examples

Message	Description
1234 1555 5555 7	Zone 1 alarm for account 1234. All other zones normal.
1234 3555 5555 7	Zone 1 restore for account 1234. All other zone normal.
1234 5155 6555 7	Zone 2 alarm with zone 5 previously reported. All other zones normal.
1234 5655 3555 7	Zone 5 restore with zone 2 previously reported.
1234 5555 5515 3	Zone 7 Shunt report.

Using the Model 8710 Digital Communicator Programmer

COMMAND # 03

RECEIVER 1 COMMUNICATION FORMAT

1 1 *Default Values*

0	3			<i>Enter</i>
---	---	--	--	--------------

(1) (2) *Digit Positions*

Receiver Format

- 1 = Slow "A", 2300 Hz ack
- 2 = Fast "A", 2300 Hz ack
- 3 = Slow "B", 1400 Hz ack
- 4 = Fast "B", 1400 Hz ack
- 5 = Sum Check, 1400 Hz ack
- 6 = Sum Check, 2300 Hz ack
- 7 = ADEMCO DTMF, 1400 Hz ack

Message Format

- 1 = 3/1 Single, .5 sec delay
- 2 = 3/1 Single, 2 sec delay
- 3 = 3/1 Extended, .5 sec delay
- 4 = 3/1 Extended, 2 sec delay
- 5 = 4/2
- 6 = 4/1
- 7 = 4/9 (ADEMCO DTMF)

COMMAND # 04 RECEIVER 2 COMMUNICATION FORMAT

This location controls the reporting formats to Receiver #2. If you have not programmed the communicator to use Receiver #2 for backup or split reporting, it will not use this information. The first Digit Position in the Command Location determines the receiver's handshake frequency and the speed of data transmission. The second Digit Position determines the number of digits in the account number, the number of digits in the alarm code, and whether it will be single or two round reporting.

Note: This Command Location must be programmed if you are using split or backup reporting.

						1	1	Default Values
0	4							Enter

						(1)	(2)	Digit Positions
Receiver Format								
1 = Slow "A", 2300 Hz ack								
2 = Fast "A", 2300 Hz ack								
3 = Slow "B", 1400 Hz ack								
4 = Fast "B", 1400 Hz ack								
5 = Sum Check, 1400 Hz ack								
6 = Sum Check, 2300 Hz ack								
7 = ADEMCO DTMF, 1400 Hz ack								
Message Format								
1 = 3/1 Single, .5 sec delay								
2 = 3/1 Single, 2 sec delay								
3 = 3/1 Extended, .5 sec delay								
4 = 3/1 Extended, 2 sec delay								
5 = 4/2								
6 = 4/1								
7 = 4/9 (ADEMCO DTMF)								

COMMAND # 05 COMMUNICATIONS CONTROL

There are 4 functions programmed in this Command Location.

Call Attempts is the first digit Position. This determines the number of dialing attempts the communicator will make, when activated. If you program backup reporting, the communicator will divide the number of Call Attempts between the two numbers. If you only program Receiver #1, or split reporting, all Call Attempts will be used by the one phone number.

If the communicator calls the programmed number of attempts and does not successfully transmit information, it will activate a Status Failed To Communicate. See Command Location # 4 STATUS REPORT on page 33

Using the Model 8710 Digital Communicator Programmer

The second Digit Position, **Dial Type**, determines how the communicator will dial. The communicator will dial either in touch-tone (DTMF tone dialing) or pulse.

Phone Ring Type is the third Digit Position. The communicator detects specific ring characteristics. Some phone systems have non-standard double rings for each ring cycle. Program this Digit Position with a 1 if the phone system generates a Ring..RingRing..Ring instead of the normal Ring.....Ring.

Note: If you program a 1 to enable Double Ring, and you are using the communicator on a standard phone system, the communicator ring detector will count two rings as one. You must double the programmed number of desired ring counts. **Example:** The communicator is installed on a standard phone system. You programmed a 1 (Double Ring) in the Phone Ring Type and a 5 in the Auto-Answer Ring Count. The communicator will answer on the 10th ring.

Auto-Answer Ring Count

The fourth Digit Position determines how many times the subscriber's phone will ring before the communicator answers the call. When the communicator answers the phone, it listens for the proper access code from the Programmer. If it does not receive the correct code, it hangs up and goes back to the idle mode. You can program from 0 to 15 (*5) rings. Programming a 0 disables remote programming.

If you program the ring count for 15 (*5), the communicator will be able to bypass the subscriber's answering machine. To bypass the answering machine, select **DIAL REMOTE ?** from the Main Menu. Press the Enter key. When the display shows **ENTER PHN NMBR ?**, type in the phone number of the dialer. Press the Enter key. Key in the number to be dialed. Press the Down arrow. Select **DTMF** or pulse dialing (**DTMF OR PULSE ?**) by pressing the Enter key followed by the Up or Down arrow. When it displays the desired dialing type, press the Enter key. Press the Down Arrow key. The display will show **EDIT PASSCODE ?**. Make changes as needed. Press the Down arrow, until the programmer displays (**ANSR MACH BYPAS?**). If you want answering machine bypass, press the Enter key, otherwise press the Down arrow.

When you select answering machine bypass, the Programmer will perform the following steps when trying to connect to the communicator. First, it will call up the communicator. It will let the phone ring once or twice. Then the Programmer will hang up the phone. After 8 seconds, it will call the subscriber back. The communicator will answer on the first ring of the second call.

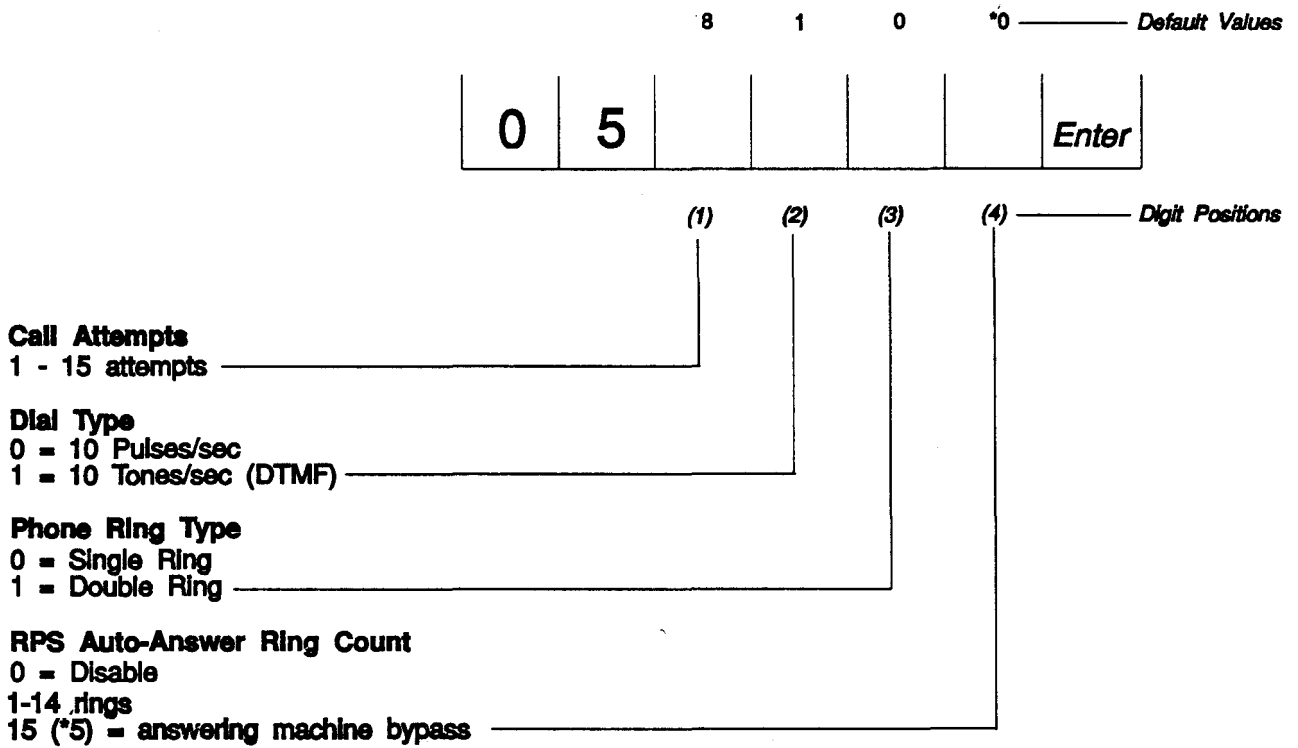

COMMAND # 06 RECEIVER 1 ACCOUNT NUMBER

This is the Account Number that will be transmitted to Receiver #1. If your receiver accepts hexadecimal numbers, you can also program A, B, C, D, E, or F. You must program all 4 positions. The account number is right justified. If it is less than 4 digits long, program in 0's at the beginning. The last digit of the account number must be in Position (4).

Check with your central station to determine how long the account number must be, and what characters the receiver can handle. Many central stations will give you the account number to program.

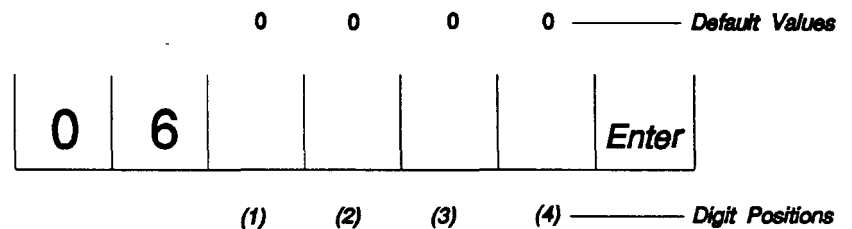

Receiver 1 Account Number
Valid entries are 0 - F (15)

COMMAND # 07 RECEIVER 1 PHONE NUMBER (6 left digits)

This is the phone number for Receiver #1, You can program up to 18 digits for the phone number. The phone number is broken down into 3 groups of 6 digits. The last digit to be dialed must be in Digit Position 6 of Command Location 9.

You can program in any number from 1 to 9, plus the number 0 (10 dialing pulses). You can also program in a *2 for the "*" on a touch-tone phone. Program in a *3 for the touch-tone "#". Program in *5 for a 2 second pause. You can program in as many pauses as needed and space will allow.

Example 1: Your central station is a local call. The phone number is 123-4567. If you wanted to send signals to Receiver #1, program the dialer

Command 07						Command 08						Command 09					
left digits						middle digits						right digits					
0	0	0	0	0	0	0	0	0	0	0	1	2	3	4	5	6	7
1	2	3	4	5	6	7	8	9	10	11	12	13	14	15	16	17	18

Example 2: Your central station is a nationwide monitoring service. The phone number is 1-800-123-4567. If you wanted to send signals to Receiver #1, program the dialer

Command 07						Command 08						Command 09					
left digits						middle digits						right digits					
0	0	0	0	0	0	0	1	8	0	0	1	2	3	4	5	6	7
1	2	3	4	5	6	7	8	9	10	11	12	13	14	15	16	17	18

Example 3: Your central station is a local call. The phone number is 555-1212. You have to dial the digit 9 before dialing the normal phone number. After you dial "9", you want to pause to insure that the second dial tone is present. Program the dialer

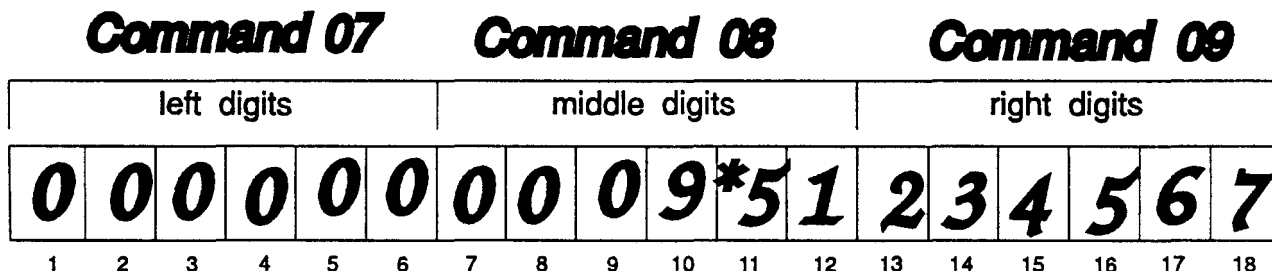

Fill in your central station phone number in the following blocks. *Write the last digit to be dialed in block #18.* All unused Digit Positions in front of the phone number must have zeroes. This will make it easy for you to see how to program the number into Command Locations 07, 08, & 09.

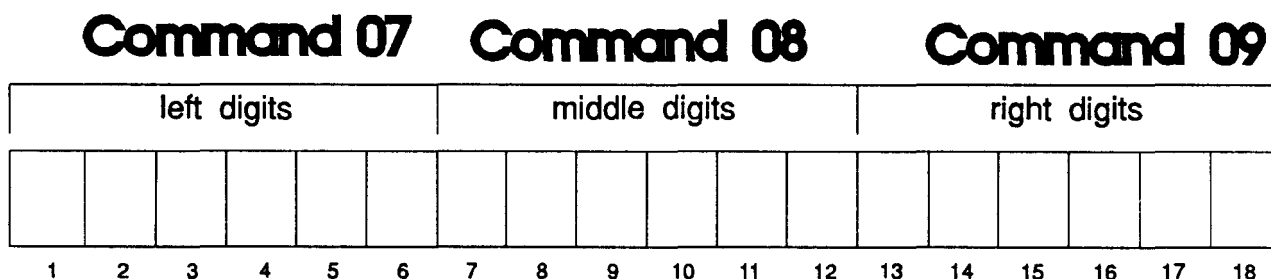

COMMAND # 07 RECEIVER 1 PHONE NUMBER (6 left digits)

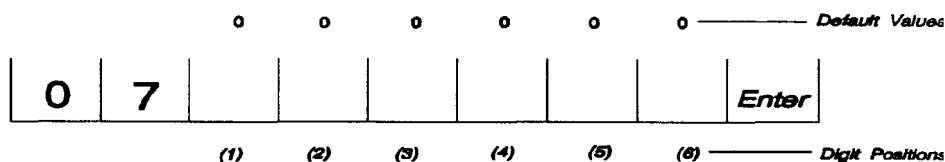

Valid telephone entries are:

- 0 - 9 decimal
- *2 = "" tone
- *3 = "#" tone
- *5 = 2 sec pause

COMMAND # 08
its)

RECEIVER 1 PHONE NUMBER (6 middle dig-

0 0 0 0 0 0 ———— *Default Values*

0	8							<i>Enter</i>
(1)	(2)	(3)	(4)	(5)	(6)	————— <i>Digit Positions</i>		

Valid telephone entries are:

- 0 - 9 decimal
- *2 = "*" tone
- *3 = "#" tone
- *5 = 2 sec pause

COMMAND # 09

RECEIVER 1 PHONE NUMBER (6 right digits)

0 0 0 0 0 0 ———— *Default Values*

0	9							<i>Enter</i>
(1)	(2)	(3)	(4)	(5)	(6)	————— <i>Digit Positions</i>		

Valid telephone entries are:

- 0 - 9 decimal
- *2 = "*" tone
- *3 = "#" tone
- *5 = 2 sec pause

COMMAND # 10 RECEIVER 2 ACCOUNT NUMBER

This is the Account Number that will be transmitted to Receiver #2. It will be used for split or backup reporting. You can program a signal to only report to Receiver #1. You could also program some signals to report to Receiver #1 and others to Receiver #2. This is called split reporting. The last option is to send all signals to receiver #1, but if they fail to report, send them to Receiver #2.

Backup reporting gives you additional transmission reliability. If the primary central station receiver, or its phone lines fail, the communicator will try to call a backup. You must program Receiver #2's phone number and account number. When trying to communicate in the backup mode, the communicator will try two dialing attempts to Receiver #1. If it cannot communicate, it will then try two dialing attempts to Receiver #2. Failing to communicate to Receiver #2, it will switch back to Receiver #1 for two more dialing attempts. It will continue in this sequence until it either communicates, or reaches the end of its dialing attempts.

If a second receiver is used, enter the account number, as specified by the central station. If not, leave the defaulted four zeroes.

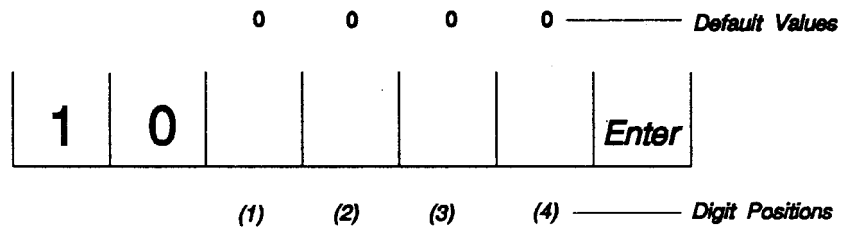

Receiver 2 Account Number

Valid entries are 0 - F (15)

COMMAND # 11 RECEIVER 2 PHONE NUMBER (6 left digits)

This is the phone number for Receiver #2. It will be used for split or backup reporting. Follow the same programming guides that you used for Receiver #1's phone number.

Fill in your central station number in the following blocks. Write the last digit to be dialed in block #18. This will make it easy for you to see how to program the number into Command Locations 11, 12, & 13.

Command 11						Command 12						Command 13					
left digits						middle digits						right digits					
1	2	3	4	5	6	7	8	9	10	11	12	13	14	15	16	17	18

COMMAND # 11 RECEIVER 2 PHONE NUMBER (6 left digits)

0 0 0 0 0 0 0 ————— *Default Values*

1	1							<i>Enter</i>
----------	----------	--	--	--	--	--	--	--------------

(1) (2) (3) (4) (5) (6) ————— *Digit Positions*

COMMAND # 12
digits)

RECEIVER 2 PHONE NUMBER (6 middle

0 0 0 0 0 0 ———— *Default Values*

1	2							<i>Enter</i>
---	---	--	--	--	--	--	--	--------------

(1) (2) (3) (4) (5) (6) ———— *Digit Positions*

COMMAND # 13
digits)

RECEIVER 2 PHONE NUMBER (6 right

0 0 0 0 0 0 ———— *Default Values*

1	3							<i>Enter</i>
---	---	--	--	--	--	--	--	--------------

(1) (2) (3) (4) (5) (6) ———— *Digit Positions*

COMMAND # 14 STATUS REPORT

STATUS CODE

Status Reports transmit vital communicator information. Two digits make up the Status Report. The first digit, Status Report Code, you program. Enter any digit from 0 to F. If you program a 0, the Status Report will be disabled.

The second digit is supplied by the communicator. When the communicator detects a change in the communicator's operational status, it transmits the Account Number followed by the Status Code, followed by one of the following codes:

Hexadecimal	Decimal	Condition
A	10	Completed remote programming
B	11	Watchdog reset
C	12	Failed to communicate

To get the complete status report, you must program the receiver communication format as a 3/1 extended or a 4/2 format. If you program a 3/1 single, 4/1 or 4/9 format, you will receive the Status Report Code, but not the exact status condition. In the following example, you programmed Account 0123 with a 9 for the Status Code, a Watchdog Reset would transmit:

Example 1: 3/1 Single	123 9
Example 2: 3/1 Extended	123 9 999 B
Example 3: 4/1 Single	0123 9
Example 4: 4/2	0123 9B
Example 5: 4/9	0123 5555 5555 6

Completed remote programming - This report is sent when you have completed programming, and disconnect from the communicator. The communicator will transmit the Status Code followed by the digit A.

Watchdog reset - The communicator has a special watchdog safeguard. The watchdog continually checks for proper microprocessor operation. If it detects a failure, the LED on the circuit board will light steadily instead of the normal flashing. The communicator will transmit the Status Code followed by the digit B. The watchdog LED can be reset in three ways. First, you can use the 8711 Remote Programming Package. Second, you can reset it using the Model 8710 Digital Communicator Programmer. Third, you can move the LOCAL/REMOTE jumper to the LOCAL position and back to REMOTE.

Failed to communicate - After the last programmed dialing attempt, if the communicator has not successfully communicated to the receiver, it will go into a failed to communicate mode. Every four hours it will automatically re-dial for the programmed dialing attempts. Once it connects to the receiver, it transmits the Status Code followed by the digit C. It will then transmit the code of any channel which was originally triggered.

Status Receiver Select

You can program the status code to report to Receiver #1 only, Receiver #2 only, or Receiver #1 with Receiver #2 as backup.

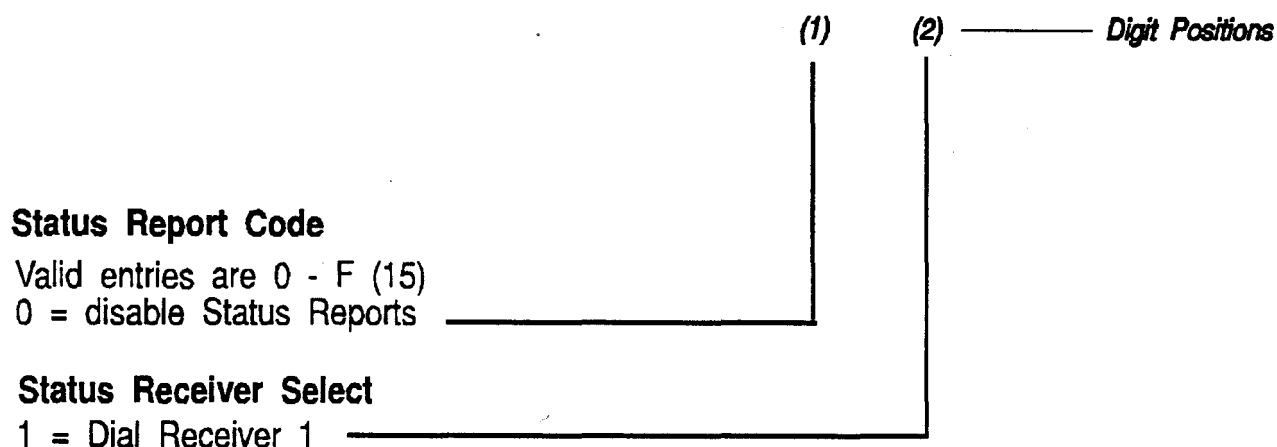
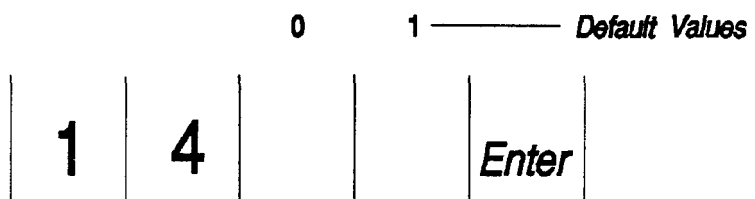

COMMAND # 15 SHUNT REPORT

The AT&T Digital Communicator has an advanced feature called Swinger Killer. This feature allows you to automatically shunt channels that transmit excessive alarms. Swinger Killer is enabled in the channel Command Locations 31-38. If you have enabled Swinger Killer, the Shunt Report Code will be transmitted followed by the number of the shunted channel. Program in any value from 1 through F. If you program in a 0, Shunt Reports will be disabled for all channels.

In the following example, If communicator channel 2 of account 0123 had been tripped excessively during the previous hour, and the Swinger Killer feature was enabled, then if you programmed a B for the Shunt Report Code, your communicator would transmit as follows:

Example 1: 3/1 Single	123 B
Example 2: 3/1 Extended	123 B BBB 2
Example 3: 4/1 Single	0123 B
Example 4: 4/2	0123 B2
Example 5: 4/9	0123 5155 5555 3

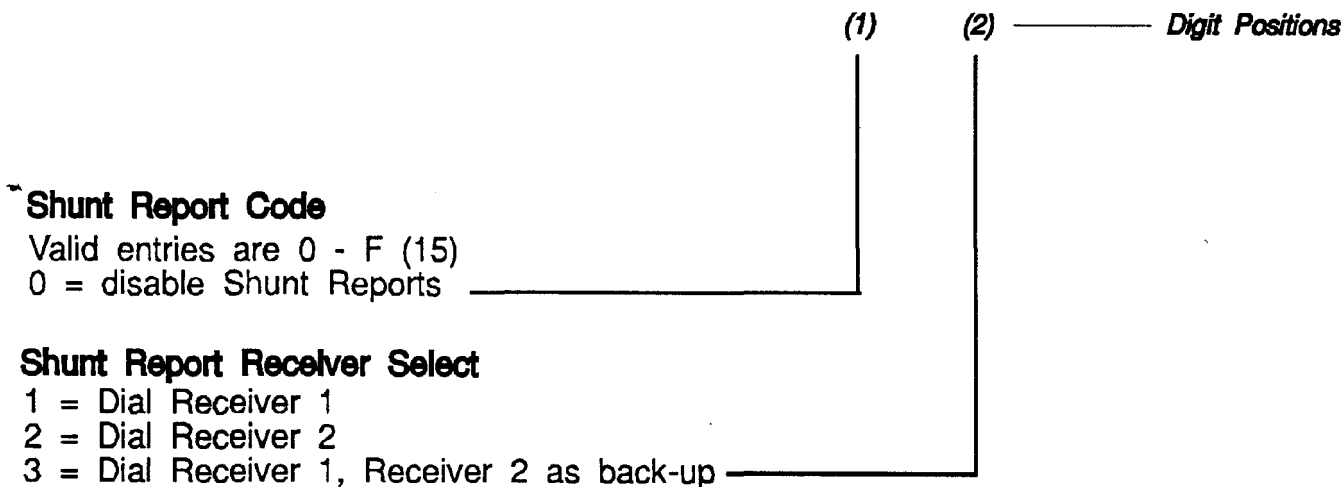
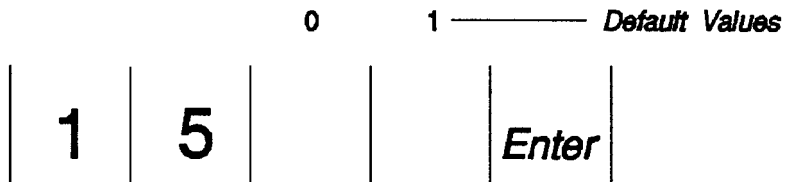

COMMAND # 16 TEST REPORT

Test reporting is an additional security feature of the AT&T Digital Communicator. You can program the communicator to periodically report in to the central station. Program in any digit from 1 through F for the Test Report Code. If you program in a 0, test reports will be disabled.

Select the receiver where you want to send the test report.

You will need to select the time between test reports. You can program the Test Report Send Interval from 1 to 31 days in 2 day increments. Once you have programmed the communicator, you can use the Programmer (or Model 8711 Remote Programming Package) to set the time when test reports will begin. Refer to **TEST RPT TIME ?** on page 12.

Once you have programmed the Digital Communicator, you can use the Digital Communicator Programmer or the Model 8711 Remote Programming Package to set the time of day that the test reports will transmit.

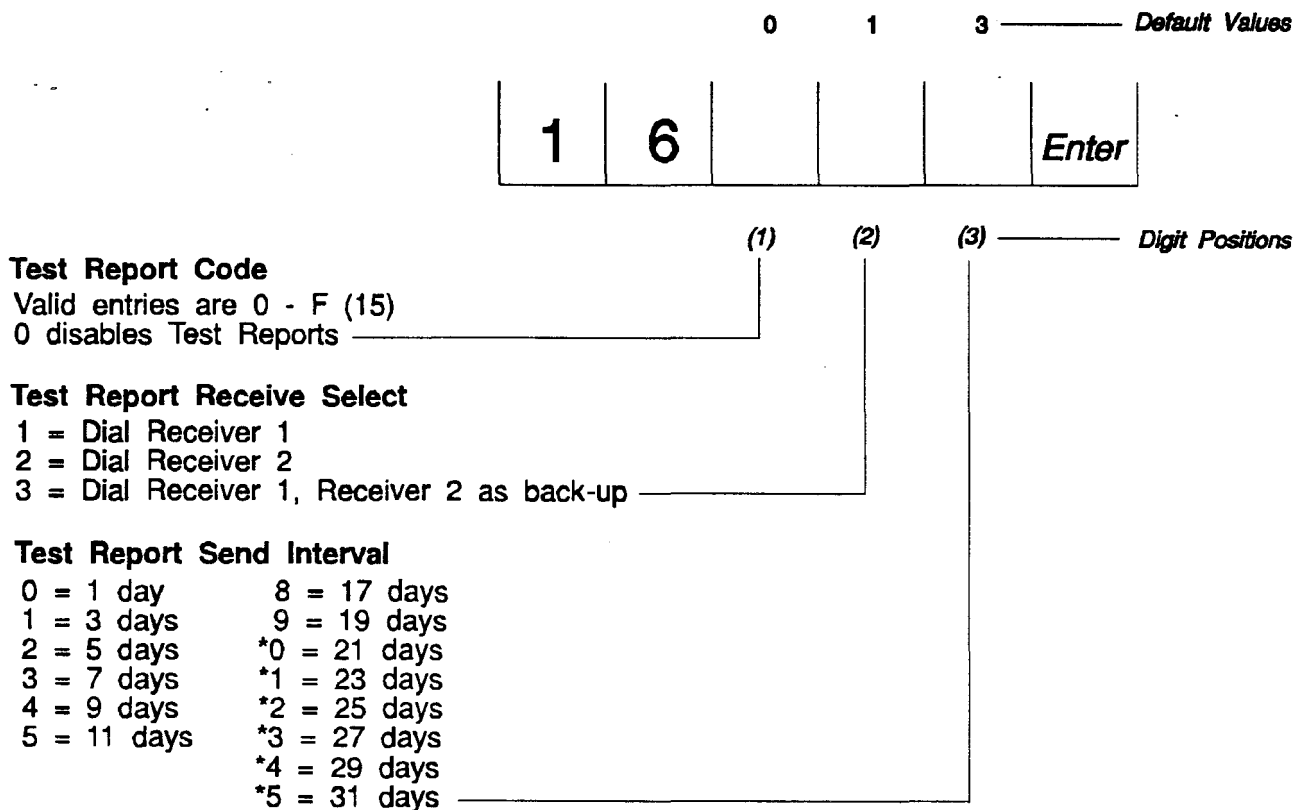

COMMAND # 31 - 38 CHANNEL 1 - 8 ALARM OPERATION

There are six programming options for each channel. You must program all 6 options for all 8 channels. Command Location 31 holds the programming values for Channel 1. Command Locations 32 through 38 hold the values for Channels 2 through 8.

1st Digit Position: Channel Alarm Reporting Code - Program in the code you want the communicator to report when the channel detects an alarm. Most dealers program a 1 for Channel 1, a 2 for Channel 2, a 3 for Channel 3, a 4 for Channel 4, a 5 for Channel 5, a 6 for channel 6, a 7 for Channel 7, and an 8 for Channel 8. Program in a 0 to disable alarms from a specific channel.

2nd Digit Position: Alarm Receiver Select - You can program each Alarm Code to report to Receiver #1 only, Receiver #2 only, or Receiver #1 with Receiver #2 as backup.

3rd Digit Position: Channel Alarm Response Time - The Digital Communicator has programmable loop response times to reduce false alarms. This is the length of time each channel must remain in alarm before the communicator transmits an alarm report. The factory default value of 100 milliseconds (.1 seconds) is the normal setting.

If you are concerned that the subscriber might cause false alarms, you can increase the Channel Alarm Response Time. If you programmed the value 3 in this Digit Position, the channel would have to remain in alarm for 30 seconds before the communicator would report.

0 = Default (100ms)	5 = 50 sec.	*0 = 100 sec.
1 = 10 sec.	6 = 60 sec.	*1 = 110 sec.
2 = 20 sec.	7 = 70 sec.	*2 = 120 sec.
3 = 30 sec.	8 = 80 sec.	*3 = 130 sec.
4 = 40 sec.	9 = 90 sec.	*4 = 140 sec.
		*5 = 150 sec.

4th Digit Position: Swinger Killer Shunt - If you have programmed a Shunt Code in Command Location 15, you can cause the communicator to automatically shunt run-away channels. The runaways may be caused by sensors on loose fitting doors or windows which keep re-triggering and cause unwanted alarms.

Swinger Killer will automatically shunt the channel if the number of alarms exceeds the value programmed into Swinger Killer Shunt over a 1 hour period of time. The 1 hour counter starts when the channel goes in to alarm. If power is removed, the clock will reset and start counting from zero as soon as power is re-applied.

Program 0 in this location if you do not want to use Swinger Killer for this channel.

5th Digit Position: Channel Restoral Reporting Code - This is the code the communicator will report when the channel returns to normal after it has reported an alarm. Program a 0 in this location if you do not wish to send restoral reports from this channel.

6th Digit Position: Restore Receiver Select - You can program the Restore Code to report to Receiver #1 only, Receiver #2 only, or Receiver #1 with Receiver #2 as backup.

COMMAND # 31 - CHANNEL #1

1 1 0 0 *4 1 ———— *Default Values*

3	1						Enter
---	---	--	--	--	--	--	-------

(1) (2) (3) (4) (5) (6) ———— *Digit Positions*

Channel Alarm Reporting Code
Valid entries are 0 - F (15)
0 disables alarm reports from that channel

Zone Alarm Receiver Select
1 = Dial Receiver 1
2 = Dial Receiver 2
3 = Dial Receiver 1, Receiver 2 as back-up

Channel Alarm Response Time
0 = default (10 ms) 8 = 80 sec
1 = 10 sec 9 = 90 sec
2 = 20 sec *0 = 100 sec
3 = 30 sec *1 = 110 sec
4 = 40 sec *2 = 120 sec
5 = 50 sec *3 = 130 sec
6 = 60 sec *4 = 140 sec
7 = 70 sec *5 = 150 sec

Swinger Killer Shunt
Valid entries are 0, 2-F(15)
0 disables Swinger Killer for that channel

Channel Restoral Reporting Code
1 - F (15).
0 disables Alarm Reports from that channel

Restoral Receiver Select
1 = Dial Receiver 1
2 = Dial Receiver 2
3 = Dial Receiver 1, Receiver 2 as back-up

COMMAND # 32 - CHANNEL #2

		2	1	0	0	*4	1	<i>Default Values</i>
3	2							<i>Enter</i>

		(1)	(2)	(3)	(4)	(5)	(6)	<i>Digit Positions</i>
Channel Alarm Reporting Code								
Valid entries are 0 - F (15)								
0 disables alarm reports from that channel								
Zone Alarm Receiver Select								
1 = Dial Receiver 1								
2 = Dial Receiver 2								
3 = Dial Receiver 1, Receiver 2 as back-up								
Channel Alarm Response Time								
0 = default (10 ms) 8 = 80 sec								
1 = 10 sec 9 = 90 sec								
2 = 20 sec *0 = 100 sec								
3 = 30 sec *1 = 110 sec								
4 = 40 sec *2 = 120 sec								
5 = 50 sec *3 = 130 sec								
6 = 60 sec *4 = 140 sec								
7 = 70 sec *5 = 150 sec								
Swinger Killer Shunt								
Valid entries are 0, 2-F(15)								
0 disables Swinger Killer for that channel								
Channel Restoral Reporting Code								
1 - F (15).								
0 disables Alarm Reports from that channel								
Restoral Receiver Select								
1 = Dial Receiver 1								
2 = Dial Receiver 2								
3 = Dial Receiver 1, Receiver 2 as back-up								

COMMAND # 33 - CHANNEL #3

3 1 0 0 *4 1 ———— Default Value

3	3							Enter
---	---	--	--	--	--	--	--	-------

(1) (2) (3) (4) (5) (6) ———— Digit Position

Channel Alarm Reporting Code

Valid entries are 0 - F (15)
0 disables alarm reports from that channel

Zone Alarm Receiver Select

1 = Dial Receiver 1
2 = Dial Receiver 2
3 = Dial Receiver 1, Receiver 2 as back-up

Channel Alarm Response Time

0 = default (10 ms)	8 = 80 sec
1 = 10 sec	9 = 90 sec
2 = 20 sec	*0 = 100 sec
3 = 30 sec	*1 = 110 sec
4 = 40 sec	*2 = 120 sec
5 = 50 sec	*3 = 130 sec
6 = 60 sec	*4 = 140 sec
7 = 70 sec	*5 = 150 sec

Swinger Killer Shunt

Valid entries are 0, 2-F(15)
0 disables Swinger Killer for that channel

Channel Restoral Reporting Code

1 - F (15).
0 disables Alarm Reports from that channel

Restoral Receiver Select

1 = Dial Receiver 1
2 = Dial Receiver 2
3 = Dial Receiver 1, Receiver 2 as back-up

COMMAND # 34 - CHANNEL #4

4 1 0 0 *4 1 ————— Default Values

3	4							Enter
---	---	--	--	--	--	--	--	-------

(1) (2) (3) (4) (5) (6) ————— Digit Positions

Channel Alarm Reporting Code

Valid entries are 0 - F (15)
 0 disables alarm reports from that channel

Zone Alarm Receiver Select

1 = Dial Receiver 1
 2 = Dial Receiver 2
 3 = Dial Receiver 1, Receiver 2 as back-up

Channel Alarm Response Time

0 = default (10 ms)	8 = 80 sec
1 = 10 sec	9 = 90 sec
2 = 20 sec	*0 = 100 sec
3 = 30 sec	*1 = 110 sec
4 = 40 sec	*2 = 120 sec
5 = 50 sec	*3 = 130 sec
6 = 60 sec	*4 = 140 sec
7 = 70 sec	*5 = 150 sec

Swinger Killer Shunt

Valid entries are 0, 2-F(15)
 0 disables Swinger Killer for that channel

Channel Restoral Reporting Code

1 - F (15).
 0 disables Alarm Reports from that channel

Restoral Receiver Select

1 = Dial Receiver 1
 2 = Dial Receiver 2
 3 = Dial Receiver 1, Receiver 2 as back-up

COMMAND # 35 - CHANNEL #5

5 1 0 0 *4 1 _____ Default Value

3	5							Enter
---	---	--	--	--	--	--	--	-------

(1) (2) (3) (4) (5) (6) _____ Digit Position

Channel Alarm Reporting Code

Valid entries are 0 - F (15)
 0 disables alarm reports from that channel

Zone Alarm Receiver Select

1 = Dial Receiver 1
 2 = Dial Receiver 2
 3 = Dial Receiver 1, Receiver 2 as back-up

Channel Alarm Response Time

0 = default (10 ms)	8 = 80 sec
1 = 10 sec	9 = 90 sec
2 = 20 sec	*0 = 100 sec
3 = 30 sec	*1 = 110 sec
4 = 40 sec	*2 = 120 sec
5 = 50 sec	*3 = 130 sec
6 = 60 sec	*4 = 140 sec
7 = 70 sec	*5 = 150 sec

Swinger Killer Shunt

Valid entries are 0, 2-F(15)
 0 disables Swinger Killer for that channel

Channel Restoral Reporting Code

1 - F (15).
 0 disables Alarm Reports from that channel

Restoral Receiver Select

1 = Dial Receiver 1
 2 = Dial Receiver 2
 3 = Dial Receiver 1, Receiver 2 as back-up

COMMAND # 36 - CHANNEL #6

6 1 0 0 *4 1 ———— *Default Values*

3	6						Enter
---	---	--	--	--	--	--	-------

(1) (2) (3) (4) (5) (6) ———— *Digit Positions*

Channel Alarm Reporting Code

Valid entries are 0 - F (15)
0 disables alarm reports from that channel

Zone Alarm Receiver Select

1 = Dial Receiver 1
2 = Dial Receiver 2
3 = Dial Receiver 1, Receiver 2 as back-up

Channel Alarm Response Time

0 = default (10 ms)	8 = 80 sec
1 = 10 sec	9 = 90 sec
2 = 20 sec	*0 = 100 sec
3 = 30 sec	*1 = 110 sec
4 = 40 sec	*2 = 120 sec
5 = 50 sec	*3 = 130 sec
6 = 60 sec	*4 = 140 sec
7 = 70 sec	*5 = 150 sec

Swinger Killer Shunt

Valid entries are 0, 2-F(15)
0 disables Swinger Killer for that channel

Channel Restoral Reporting Code

1 - F (15).
0 disables Alarm Reports from that channel

Restoral Receiver Select

1 = Dial Receiver 1
2 = Dial Receiver 2
3 = Dial Receiver 1, Receiver 2 as back-up

COMMAND # 37 - CHANNEL #7

7 1 0 0 *4 1 ———— *Default Value*

3	7							Enter
---	---	--	--	--	--	--	--	-------

(1) (2) (3) (4) (5) (6) ———— *Digit Position*

Channel Alarm Reporting Code

Valid entries are 0 - F (15)
0 disables alarm reports from that channel

Zone Alarm Receiver Select

1 = Dial Receiver 1
2 = Dial Receiver 2
3 = Dial Receiver 1, Receiver 2 as back-up

Channel Alarm Response Time

0 = default (10 ms)	8 = 80 sec
1 = 10 sec	9 = 90 sec
2 = 20 sec	*0 = 100 sec
3 = 30 sec	*1 = 110 sec
4 = 40 sec	*2 = 120 sec
5 = 50 sec	*3 = 130 sec
6 = 60 sec	*4 = 140 sec
7 = 70 sec	*5 = 150 sec

Swinger Killer Shunt

Valid entries are 0, 2-F(15)
0 disables Swinger Killer for that channel

Channel Restoral Reporting Code

1 - F (15).
0 disables Alarm Reports from that channel

Restoral Receiver Select

1 = Dial Receiver 1
2 = Dial Receiver 2
3 = Dial Receiver 1, Receiver 2 as back-up

COMMAND # 38 - CHANNEL #8

8 1 0 0 *4 1 ———— *Default Values*

3	8						Enter
---	---	--	--	--	--	--	-------

(1) (2) (3) (4) (5) (6) ———— *Digit Positions*

Channel Alarm Reporting Code

Valid entries are 0 - F (15)
0 disables alarm reports from that channel

Zone Alarm Receiver Select

1 = Dial Receiver 1
2 = Dial Receiver 2
3 = Dial Receiver 1, Receiver 2 as back-up

Channel Alarm Response Time

0 = default (10 ms)	8 = 80 sec
1 = 10 sec	9 = 90 sec
2 = 20 sec	*0 = 100 sec
3 = 30 sec	*1 = 110 sec
4 = 40 sec	*2 = 120 sec
5 = 50 sec	*3 = 130 sec
6 = 60 sec	*4 = 140 sec
7 = 70 sec	*5 = 150 sec

Swinger Killer Shunt

Valid entries are 0, 2-F(15)
0 disables Swinger Killer for that channel

Channel Restoral Reporting Code

1 - F (15).
0 disables Alarm Reports from that channel

Restoral Receiver Select

1 = Dial Receiver 1
2 = Dial Receiver 2
3 = Dial Receiver 1, Receiver 2 as back-up

TECHNICAL SPECIFICATIONS

Physical

Size: 6.125" x 3.5" x 1.75"

Weight: 12 ounces

Environmental

Temperature Range: +40 degrees to +120 degrees F.

Humidity Range: 0 to 95% Noncondensing

Power Supply

Model 8700 Digital Communicator using Direct Connect Programming Cord

or

AT&T Power Converter (110VAC to 9.0VDC @300mA)

Power Consumption: 40 mA

Protection: 3AG .25 amp fast blow fuse. Circuit polarity protected

Telephone

Phone System Type: Loop start, either pulse or DTMF (tone) dialing

FCC Registration: FCC Number:

Ringer Equivalence: 1.2B

FCC Registration and Repair Information

Your new AT&T product has been registered with the Federal Communications Commission (FCC). This product complies with standards in Part 68 of the FCC Rules. The FCC requires us to provide you with the following information:

1. Connection and use with the nationwide telephone network.
The FCC requires that you connect your product to the nationwide telephone network through a modular telephone outlet or jack. The modular jack to which this equipment must be connected is a USOC RJ-31X. If an RJ-31X connector is not already installed, the telephone company must be informed. This equipment may not be used with Party Line Service or Coin Telephone Lines.
2. Notification to the telephone company.
Upon request of your local telephone company, you are required to provide the with the following information:
 - A. The "line" which you will connect the telephone equipment (that is, your phone number), and
 - B. The telephone equipment's FCC registration number and ringer equivalence number (REN). Those numbers are on the back or bottom of you telephone equipment.
3. Repair Instructions
If it is determined that your telephone equipment is malfunctioning, the FCC requires that it not be used and that it may be unplugged from the modular outlet until the problem has been corrected. Repairs to this telephone equipment can be made only by the manufacturer or its authorized agents or by others who may be authorized by the FCC. For repair procedures, contact your AT&T authorized security dealer. The main address is AT&T, 5 Wood Hollow Rd., Parsippany, NJ 07054

Using the Model 8710 Digital Communicator Programmer